



NTSC U/C

PlayStation[®]

**ACTION
ADVENTURE
THRILLER**

KAGERO[™]

Deception II

Buy this game and get a
FREE 6-month
subscription to
PS Extreme



TECMO[®]

SLUS-00677

WARNING: READ BEFORE USING YOUR PLAYSTATION® GAME CONSOLE.

A very small percentage of individuals may experience epileptic seizures when exposed to certain light patterns or flashing lights. Exposure to certain patterns or backgrounds on a television screen or while playing video games, including games played on the PlayStation game console, may induce an epileptic seizure in these individuals. Certain conditions may induce previously undetected epileptic symptoms even in persons who have no history of prior seizures or epilepsy. If you, or anyone in your family, has an epileptic condition, consult your physician prior to playing. If you experience any of the following symptoms while playing a video game – dizziness, altered vision, eye or muscle twitches, loss of awareness, disorientation, any involuntary movement, or convulsions – IMMEDIATELY discontinue use and consult your physician before resuming play.

WARNING TO OWNERS OF PROJECTION TELEVISIONS:

Do not connect your PlayStation game console to a projection TV without first consulting the user manual for your projection TV, unless it is of the LCD type. Otherwise, it may permanently damage your TV screen.

HANDLING YOUR PLAYSTATION® DISC:

- This compact disc is intended for use only with the PlayStation® game console.
- Do not bend it, crush it or submerge it in liquids
- Do not leave it in direct sunlight or near a radiator or other source of heat.
- Be sure to take an occasional rest break during extended play.
- Keep this compact disc clean. Always hold the disc by the edges and keep it in its protective case when not in use. Clean the disc with a lint-free, soft, dry cloth, wiping in straight lines from center to outer edge. Never use solvents or abrasive cleaners.

TABLE OF CONTENTS

Setting3
Main Characters3
Your Mission4
Getting started5
Starting your Mission6
Controller Configuration9-10
Intermission11
Choosing your Traps11-13
3D Battle14-17
The Reference18-21
Clues to Conquer22
Credits23-24
Warranty Information25

Setting

There is a world where humans and Timenoids have existed together for generations. The Timenoids are physically identical to the humans in every way but one: they have blue blood coursing through their veins, which also makes their skin blue. Because Timenoids are immortal they enjoy a ruling status over the humans.

The Timenoid castle is located deep in a thick forest. A girl, Millennia, dwells in this castle with one purpose alone: she's on a mission to kill the humans. Though she's also a human, she's been brainwashed by her foster mother, Yocal, into fighting as a mercenary for the Timenoids. Yocal has successfully brainwashed Millennia into believing that the very existence of humans is wrong. Millennia can obtain immortality and become a Timenoid herself if she successfully exterminates the human race. Although Yocal has taught Millennia only how to use the traps to kill the humans, Millennia is confident that this skill is enough for her to win her battles.

Main Characters

Millennia: The main character, a human. Millennia was kidnapped and raised by Yocal as the test subject in an experiment called "the Marionette Project." She can barely remember her childhood.

Yocal: Millennia's foster mother, a Timenoid. She created and directs the "Marionette Project," a scheme designed to train humans as soldiers working for the Timenoids. Their mission is to hunt humans.

Keith: Captain of the guerrilla organization "Red Blood." Keith has a personal vendetta against the Timenoids.

King Eclipse: Ruler of the Timenoids for over 800 years. Eclipse is disturbed by the arrogance growing among the humans during the last few hundred years.

Your Mission

You, as Millennia, must protect the castle of the Timenoids by killing invaders. You may use traps and devices in the castle to accomplish your mission. The game unfolds according to the choices you make. Kagero has a non-linear scenario, meaning that the game will play out depending upon the choices you make. Think you've got this game beat? Well, you'd better try again, because Your choices will determine the path your game will take...and the particular ending you will reach.

HOW TO KILL INVADERS

Using yourself as human bait, you must lure invaders into the devices (which have already been set in the castle) and the traps that you've set. If you utilize the geographic features in each room wisely, such as stairways and watercourses, you can increase the effect of the traps.

Traps

You can set the traps anywhere and activate them at will to kill invaders. (refer to P.19)

Devices

Devices have already been set in place. You cannot change their location or activate them on your own. (refer to P.20)



Getting Started

Insert the Kagero: Deception II game disc and close the console cover. Insert a game controller and turn the PlayStation console ON. The opening story will begin, and then the Title/game start menu will appear. Press the start button to begin playing. Follow the on-screen instruction to start a game. Choose "NEW GAME" to begin a new game, or "LOAD GAME" to resume playing a saved game. OPTION SCREEN: configure your controller, or view non-playable demos of Dead or Alive and Monster Rancher.

Console

Top View

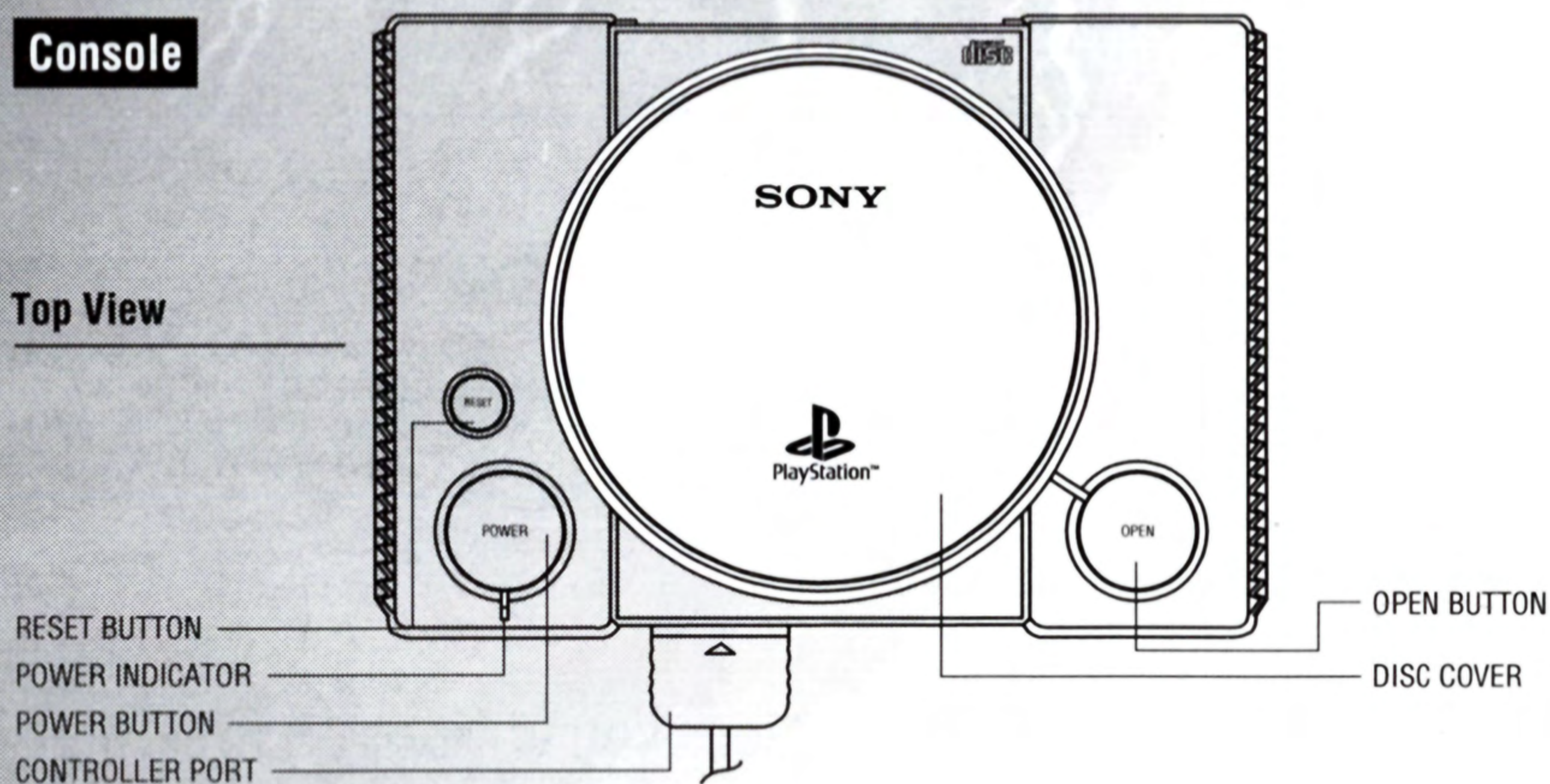

Console

Front View

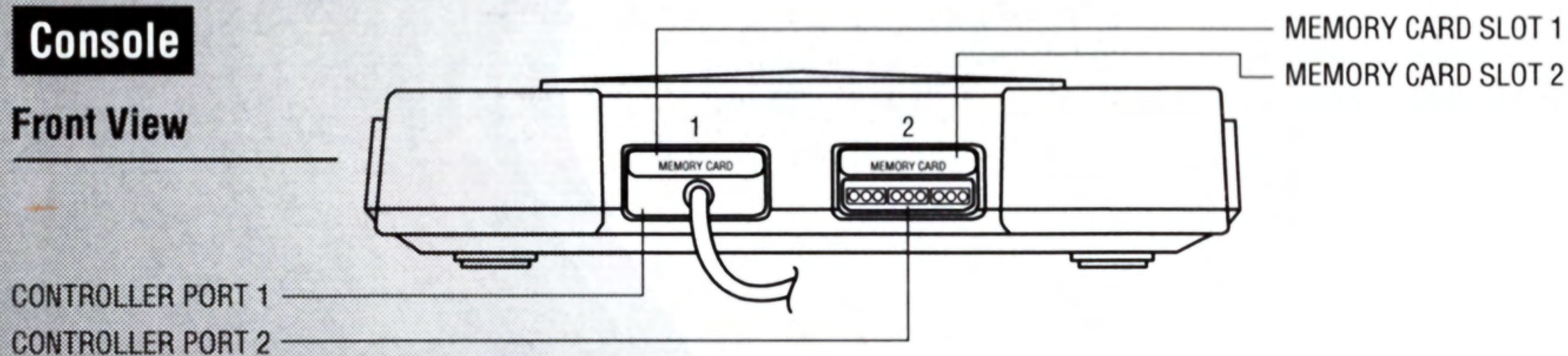

Starting Your Mission



When you choose "**NEW GAME**" you can either play as Millennia, or rename the main character with a name up to 12 characters long. When you choose "**LOAD GAME**" a saved game will be loaded from your memory card. Choose the data you want to load so that you can start the game with the same screen you saved at the end of your last game.

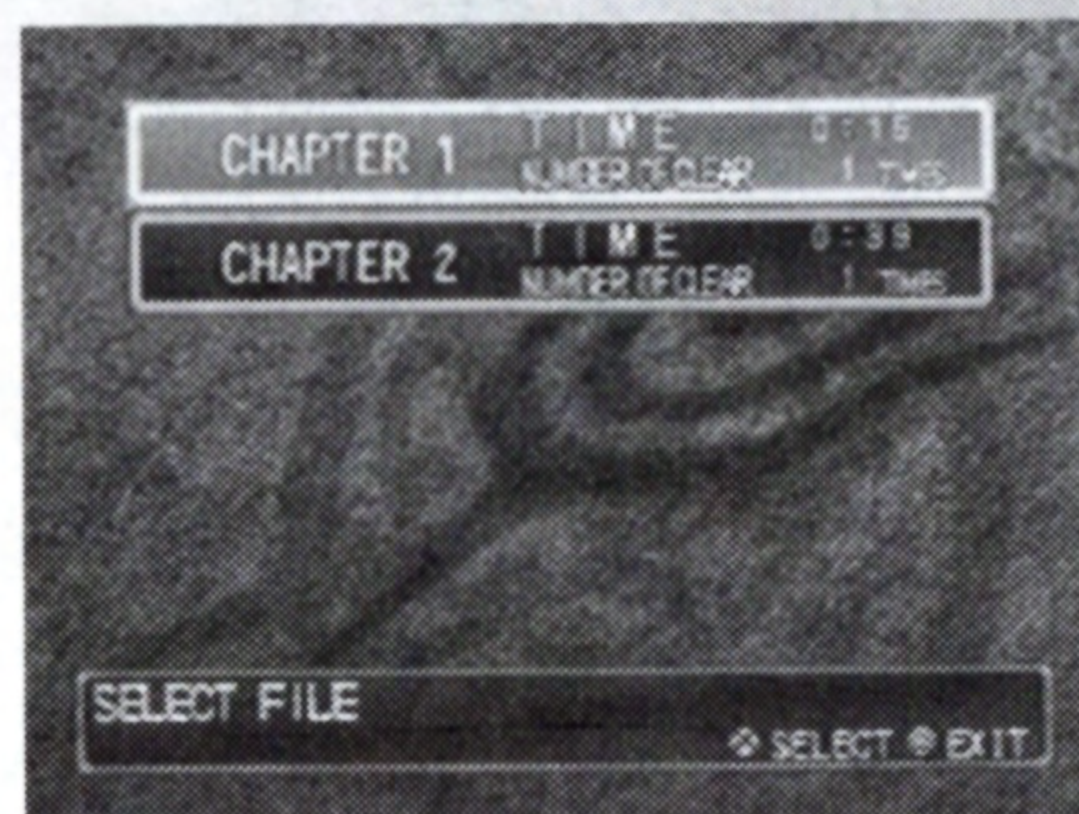
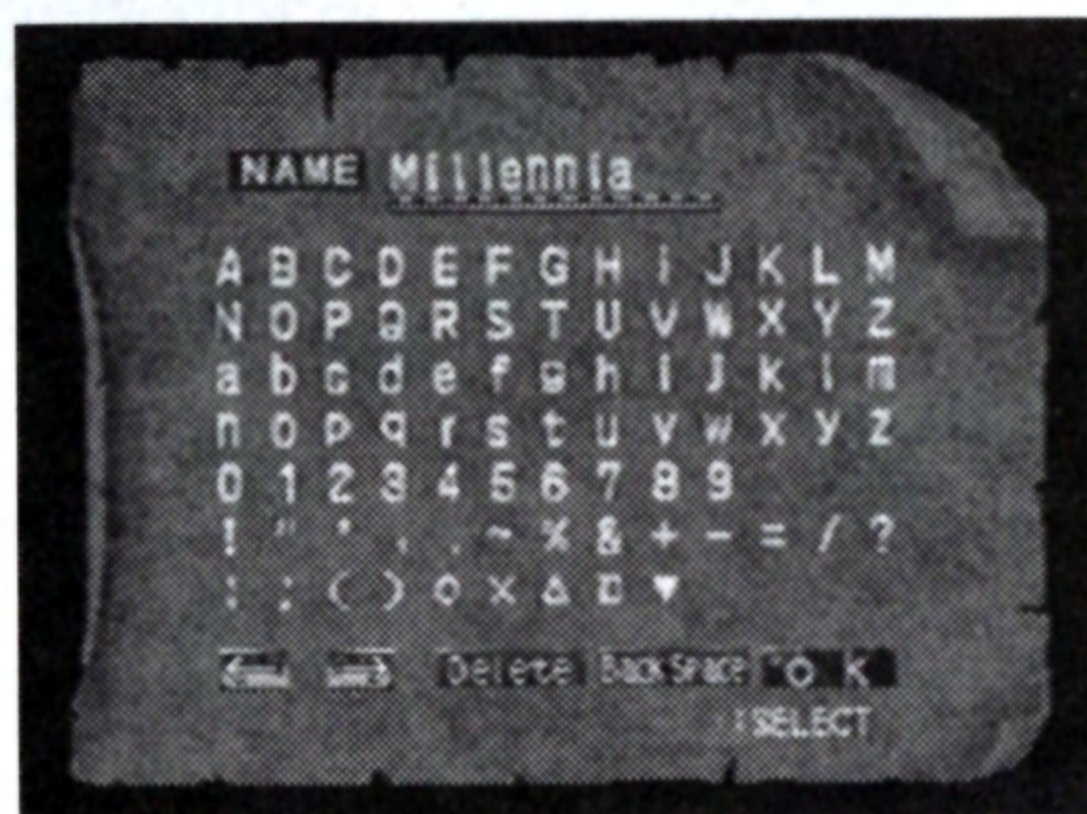

HOW TO PROCEED WITH THE GAME

Scene Explanation

Each mission is set up in 5 parts as follows:

1. Announcement of the Invaders

This announcement will tell you what kind of invaders you will meet next.

2. Intermission

This is the preliminary preparation stage. You can make new traps, and use a map to familiarize yourself with the castle floor plan and the devices in it. You can also choose the traps you want to use.

3. 3D Battle

This is the battle stage. In this section you will set the traps to trap the invaders.

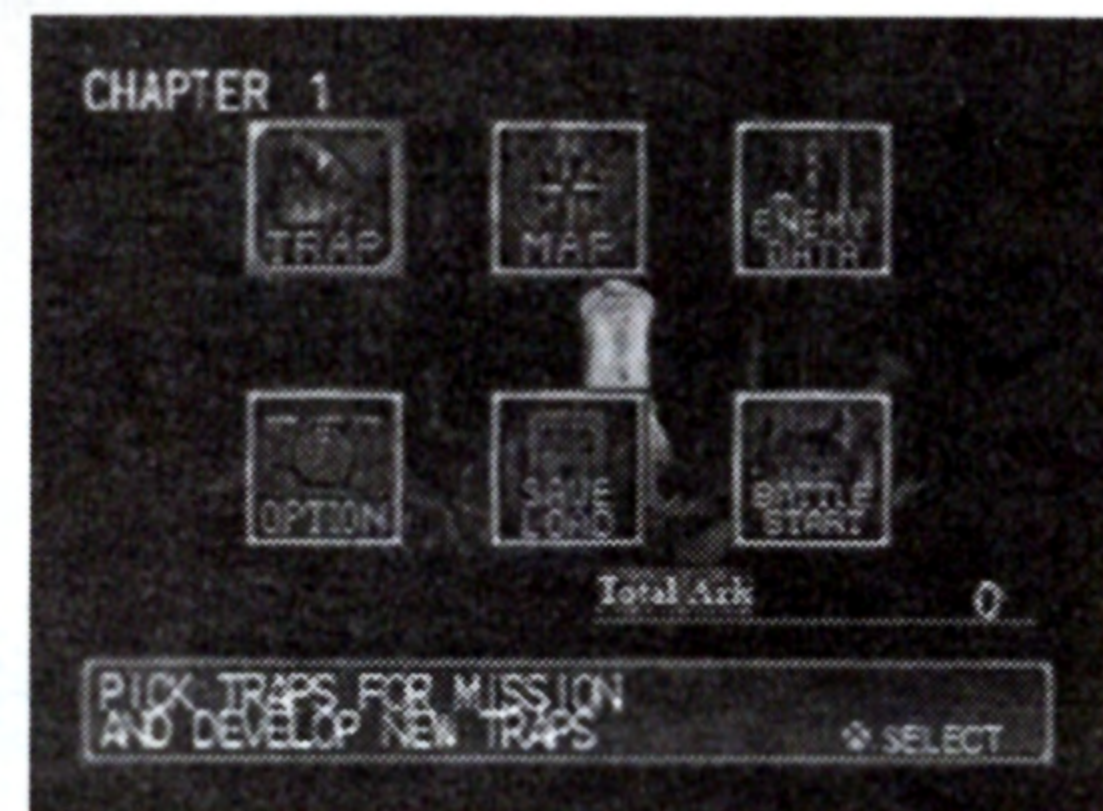
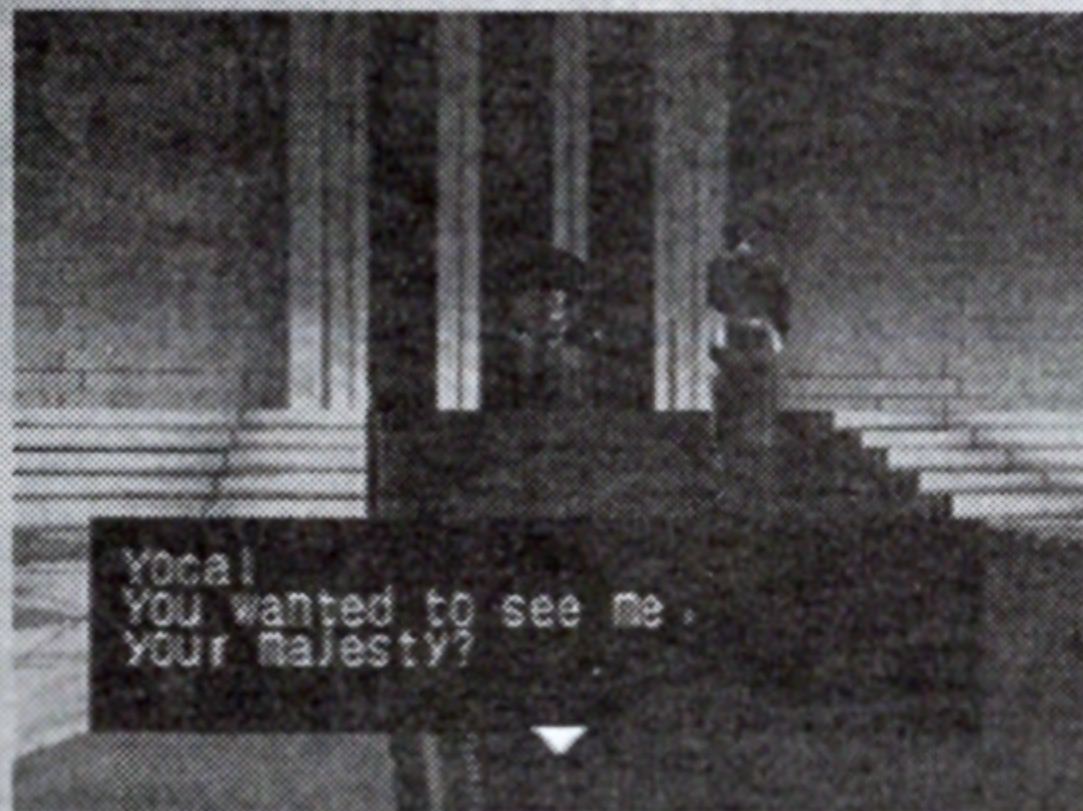

4. End of the Mission

The story unfolds at the conclusion of each mission.

5. Battle Evaluation

Your battle in the 3D battle stage will be evaluated and "Ark" will be given depending on the results of the game. Accumulate Arks to create more powerful traps.

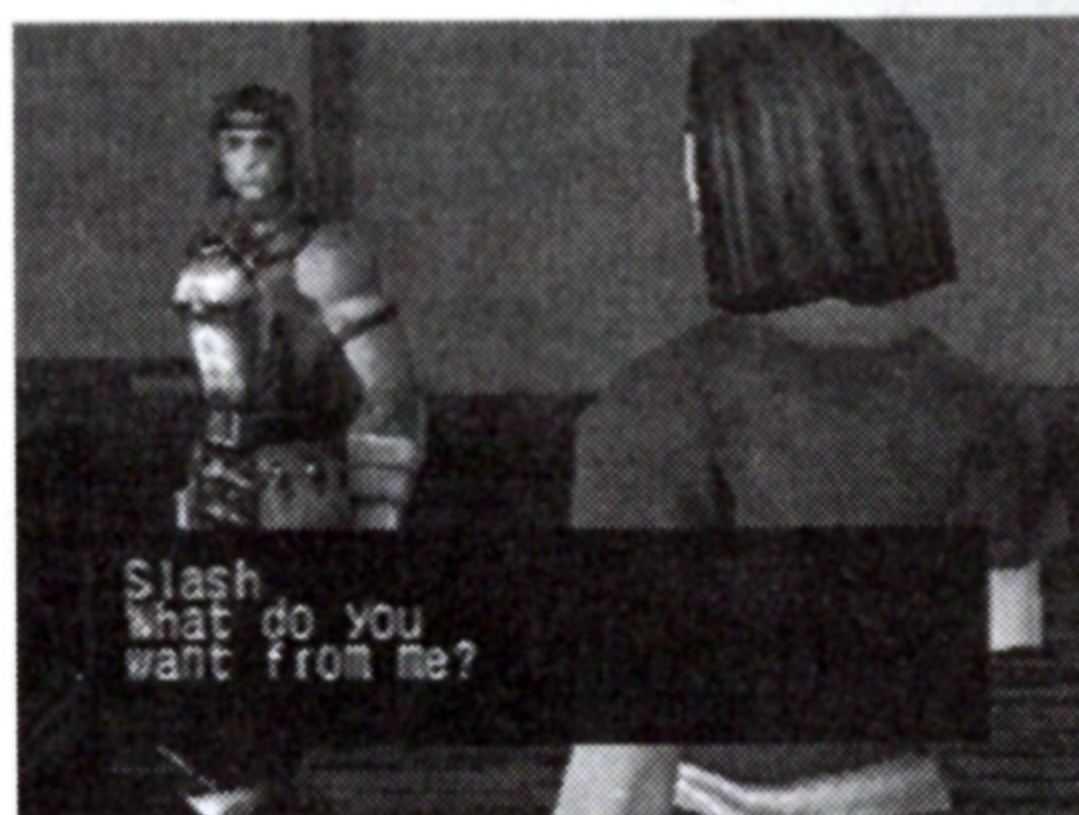
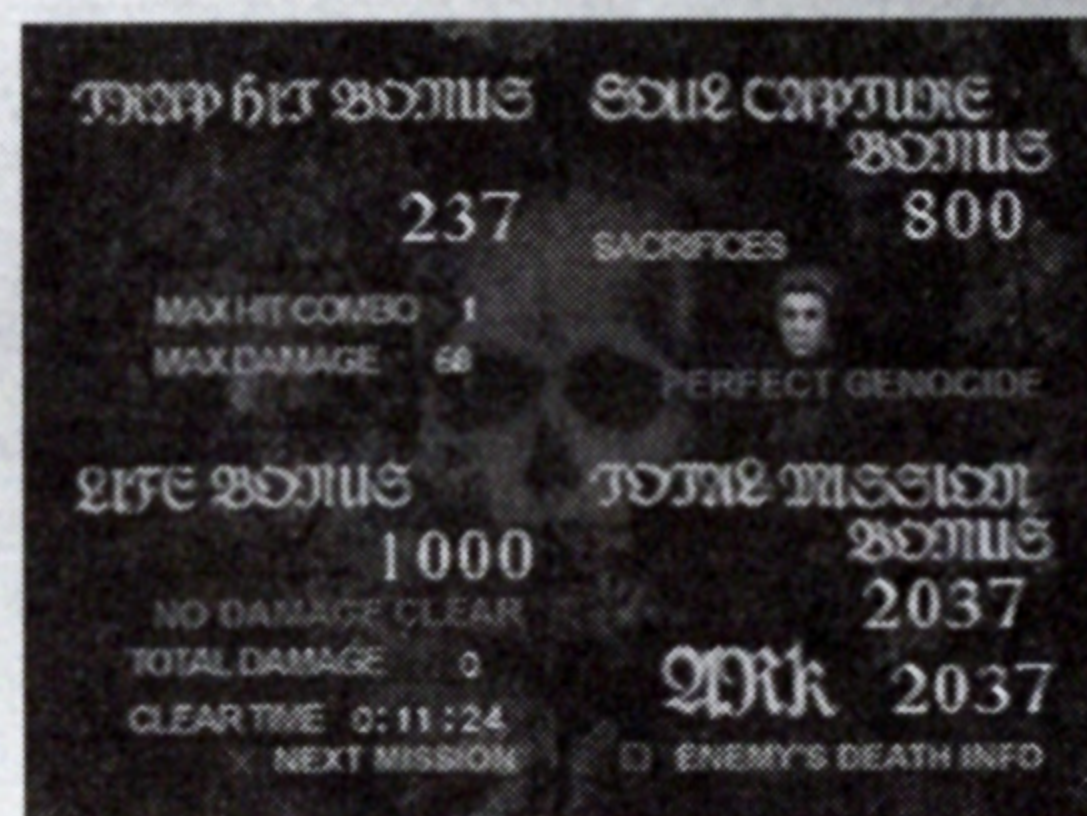
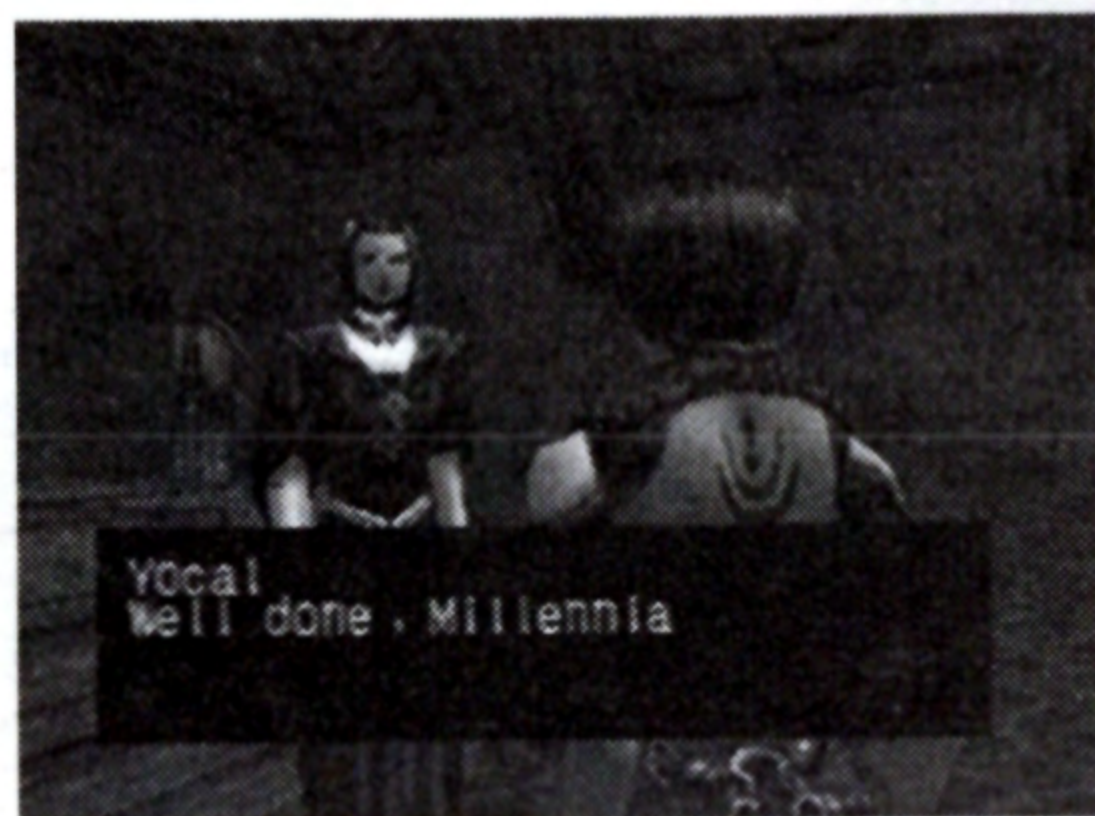

CONTROLLER CONFIGURATION

You can choose one of three controller set-ups: A, B, C, under Options during Intermission. The following is an explanation of the type A controller.

A. Operation of the Controller During the 3D Battle

Pan up, down, left, and right. L2 BUTTON + 

Step to the left L1 BUTTON

Step forward 

Turn left 

Step back 

Turn right. 

Display submenu (During Pause mode) 

Rotate L1 BUTTON + R1 BUTTON

Face the invader R2 BUTTON

Step to the right R1 BUTTON

Activate ceiling trap 

Trap Screen Mode (Camp Mode) 

Activate floor trap 

Activate wall trap 

Pause gameplay 

Controller

Top View

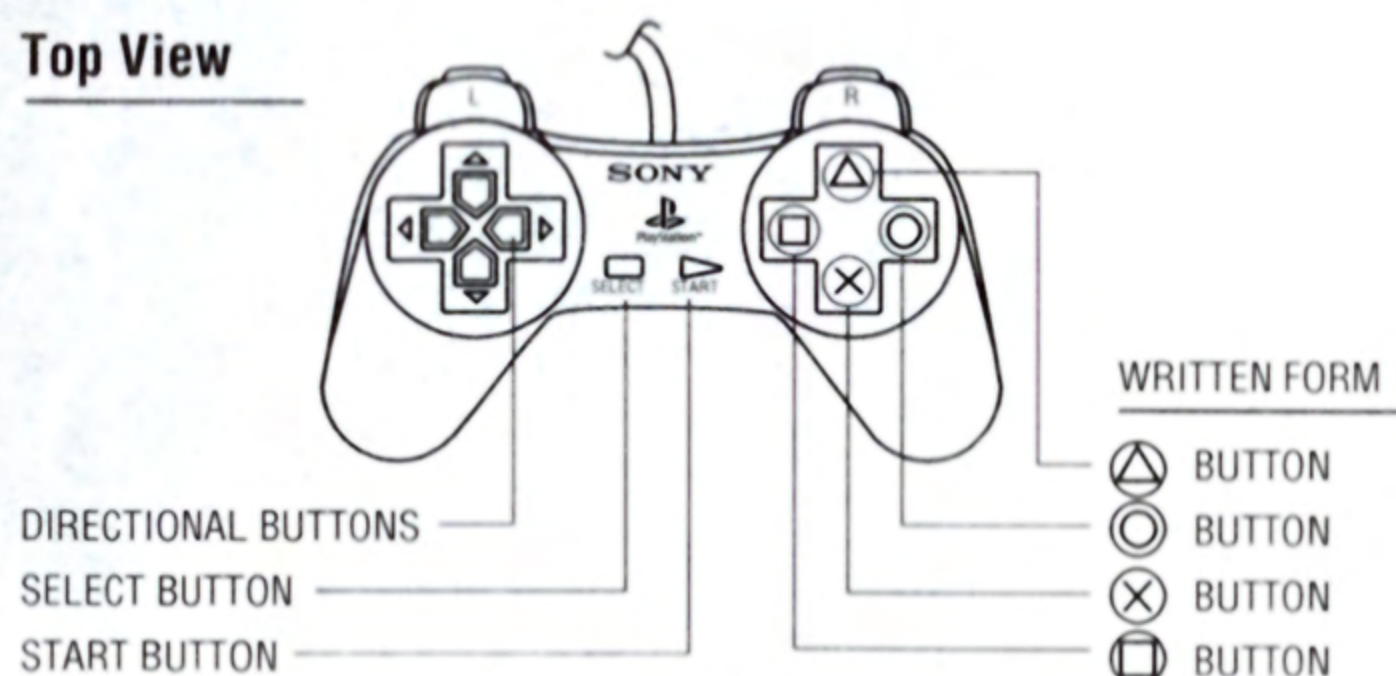

Controller

Front View

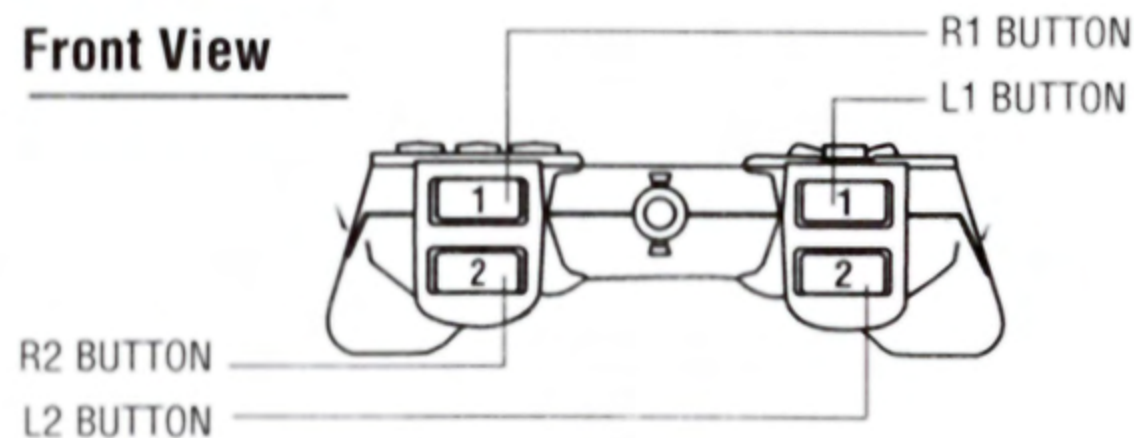

B. Controller Operations...other than during the 3D Battle

Zoom in when setting traps **L2 BUTTON**

Pan counter-clockwise when setting traps **L1 BUTTON**

Move cursor    

Not used  SELECT

Skip through dialogue and movies  START

Zoom out when setting traps **R2 BUTTON**

Pan clockwise when setting traps **R1 BUTTON**

Cancel 

Delete traps (in Trap Screen Mode) 

Confirm 

Move cursor to opposite wall 

C. Dual Shock Analog Controller

Battle more realistically by using the Dual Shock Analog Controller. Controller vibrates when traps are set off or when you are hit, in either Digital Mode (LED indicator is turned off) or Analog Mode (LED indicator is red). You can turn the vibration on or off in "BUTTON Config" under the Option menu. (refer to P.13) Right and left analog wands are not used in this game. The rest of the analog controller operations are the same as those on a standard controller (above).

INTERMISSION

You can familiarize yourself with the trap settings and the invaders' abilities before entering 3D Battle.

You can also set up the Controller, save, and load the game in this section.

A. Traps

"Trap Select," "Trap Data," and "Trap Make" are found under Trap Command.

Trap Select

You can choose from up to 3 different traps each for use on the wall, floor and ceiling. A maximum of 9 kinds of traps can be set during any mission. Even if more than 9 kinds of traps have become available to you, you can choose only 9 to use in the mission. The right window on the screen indicates the traps that have been chosen. The left window displays your entire collection of traps. Select "Wall," "Ceiling," or "Floor" to display the corresponding traps.

Choosing your Traps

1. Choose a trap you want to use from the left window on the screen.
2. Choose a trap you want to replace from the right window on the screen.

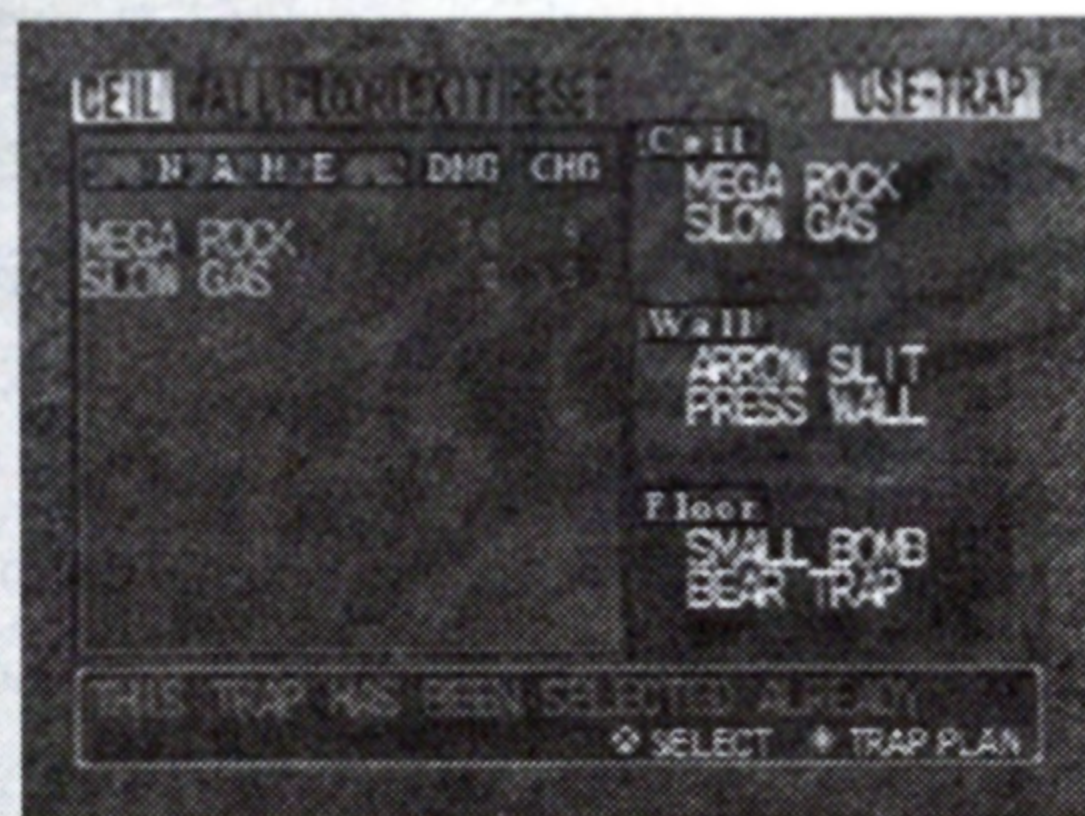

Trap Data

Display the data for traps that have already been developed. Select "Wall," "Ceiling," or "Floor" to display the traps that are ready to use.

Trap Make

You can develop new traps at the end of each mission by using "Ark" you have earned. The traps that are available to you will be highlighted.

Conditions for Development

In order to develop a more superior trap, an inferior trap needs to have already been developed. Traps which exceed your Ark budget will not be made available to you.

B. Map

Display this map to familiarize yourself with the floor plan, geographic features of the castle, and devices.

C. Enemy Data

Familiarize yourself with the invaders' in the upcoming mission. Choose "Enemy Data," to display a list of the invaders you will meet. Select the invader's face to display more detailed information about him or her.

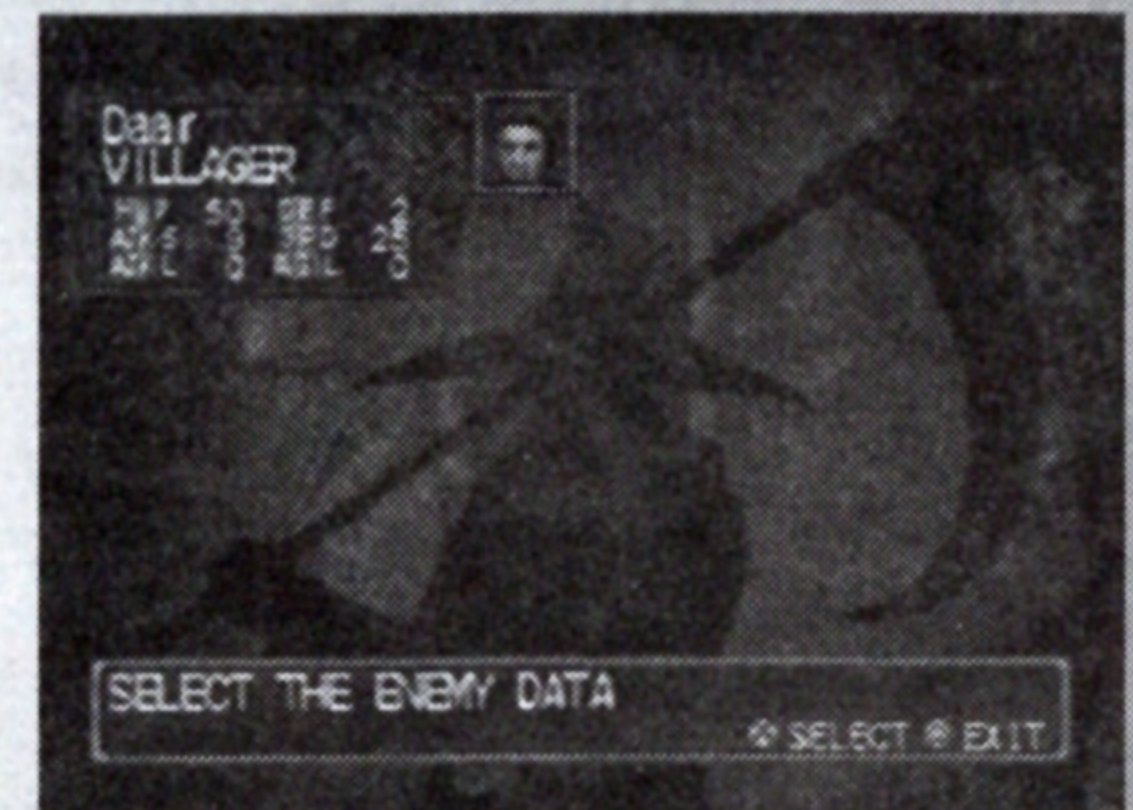
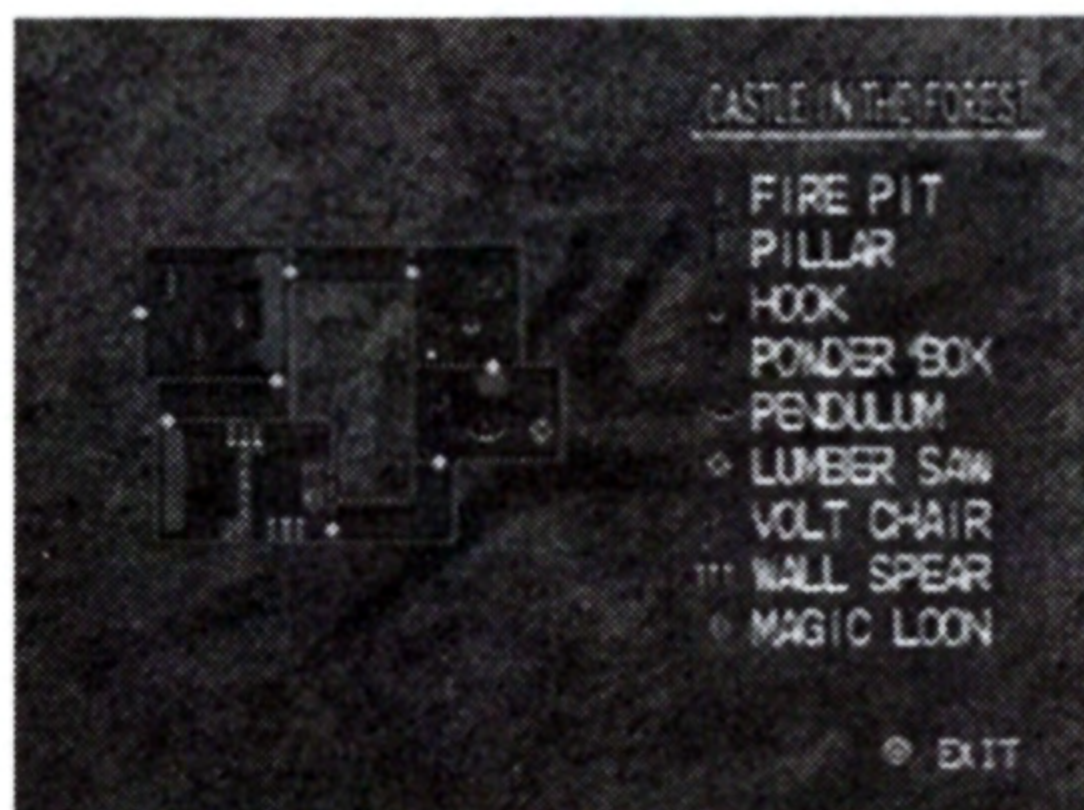

D. Options

Customize your controller operations under "CONFIGURATION." Adjust sound, BGM volume, SE volume, vibration, and trap hit camera under "SET UP."

E. Save & Load

Save your game data onto a memory card. You can also load previously saved data with this option. Each saved game requires 1 block of memory.

F. Battle Start

Intermission is over and the 3D battle will begin.

G. Reset

During gameplay press start then press select to display reset menu. Select "Quit" to start a new game.

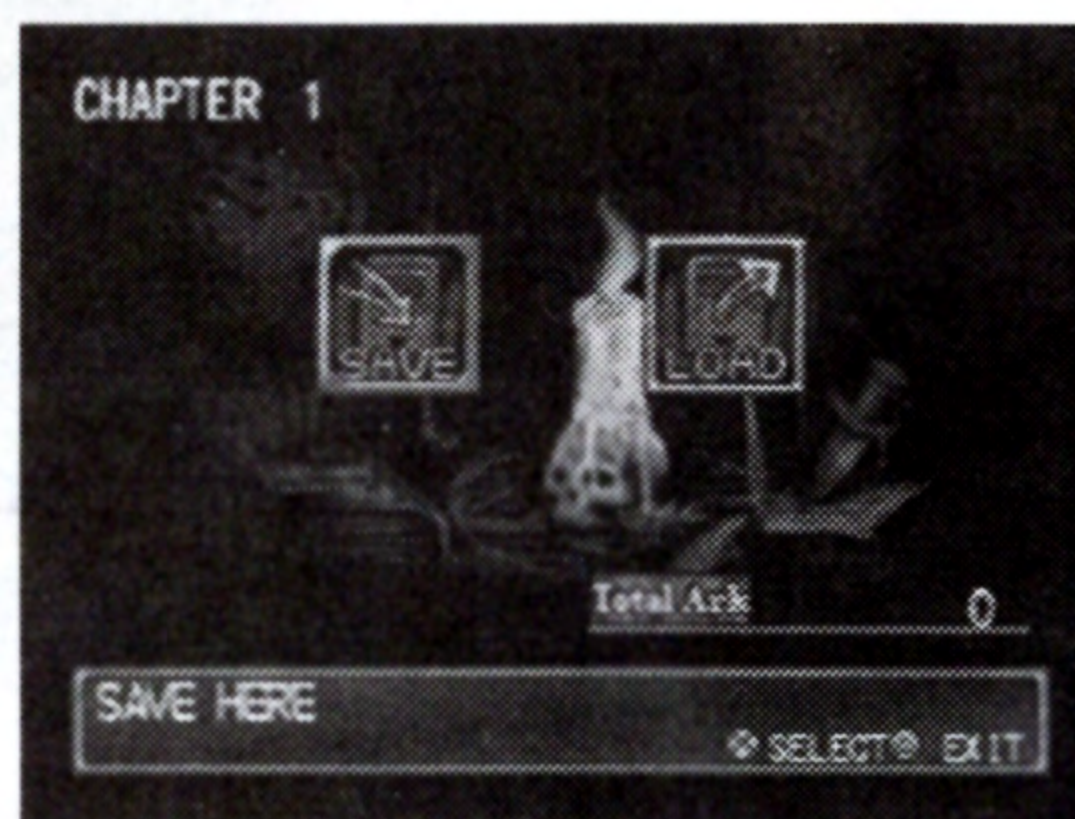

CHAPTER 2

Castle of Doom

3D BATTLE

During 3D Battle you can activate the traps and kill the invaders, press **Ⓞ** to enter Trap Screen Mode to set the traps up, and check data about invaders.

A. Screen Explanation

During the 3D Battle, the screen indicates your hit points, the invaders' hit points, and types of the traps set in the room.

The Invaders' Data Window

You

Hit Point Bar

The Invader

Trap Charge Time Bar

The following may happen to you when you are attacked by an invader or caught by the traps and devices:

Poison- You will slowly lose stamina

Confusion- Vision will be distorted and movement will be impeded

Covered with Oil- Be careful of coming into contact with open flame!

Paralyzing- Your body will stiffen and become immobile

Slow- Your movements will be slowed

Blind- You can only see objects up close

These abnormal conditions will only affect you temporarily



B. Trap Screen

If you press **○** during the 3D Battle, Trap Screen will appear.

As soon as you enter this mode, a map indicating the floor plan, your position, and the invader's position will appear. Choose any of the three commands which appear: "Enemy Data," "Map," and "Trap Set."

Enemy Data

You can check data on the Invaders during the mission. The screen looks the same as in "**Enemy Data**" mode during Intermission. However, on this screen, the surviving invaders are listed under "Target," and invaders who have already been killed are listed under "Dead." In the "Dead" list, the player can check which traps were used to kill the invaders.

Map

You can check the geographic features of each room and the devices set in it.



Trap Set

You may set traps in the room you are currently in. However, you cannot set traps under the following conditions:

(a) two traps cannot be set in the same place (b) traps cannot be set in hallways (c) traps cannot be set in the same place where previously activated traps have not disappeared yet.

Additionally, activated traps cannot be moved to different locations.

Traps must be reset after they have been deactivated.

L1 BUTTON , **R1 BUTTON** rotates your view, and **L2 BUTTON** , **R2 BUTTON** zooms in and out.

How to Set Traps



Use **▲** **▼** **◀** **▶** and **⊗** to set traps.

Choose Ceiling, Wall, or Floor.

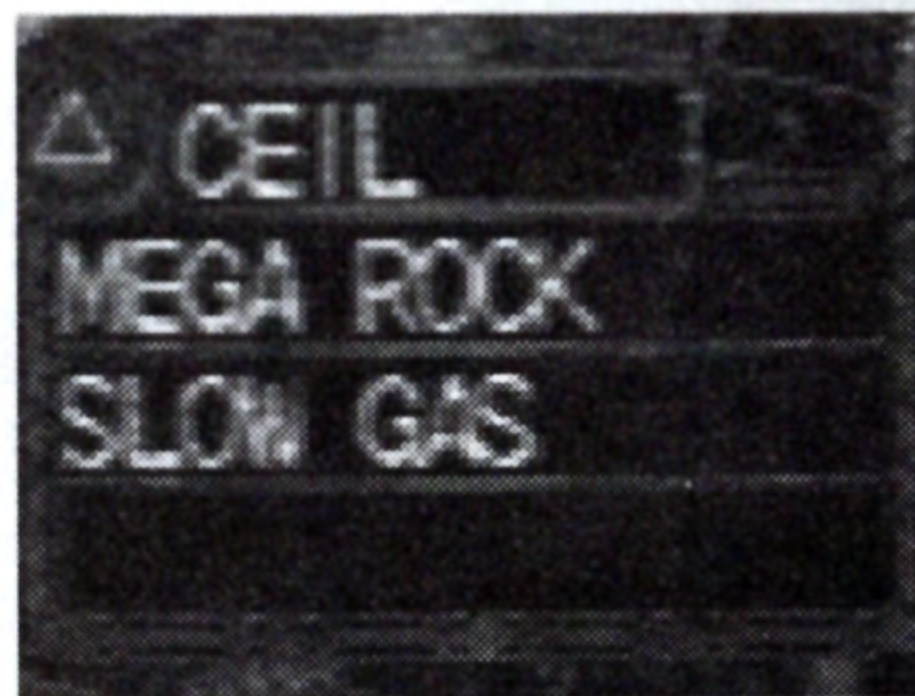
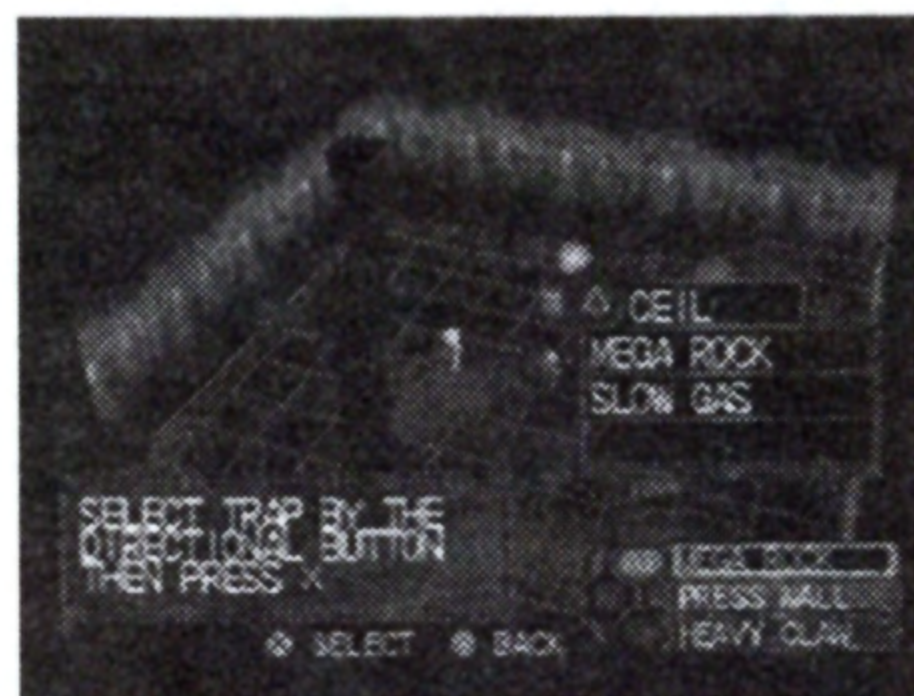
Choose the trap you want to set up in one of the above sections from the trap list. * You can set one trap in each section of the room (ceiling, wall, floor) for a total of three traps per room. Select the place where you want to set your trap. If you want to set up traps in other sections of the room, or if you want to change the settings you have already chosen, you must start from the beginning. You cannot set up a trap for the ceiling and a trap for the floor on the same block.



C. Trap Activation

Use  to activate ceiling traps,  to activate wall traps, and  to activate floor traps. All traps can also be activated simultaneously. Immediately after the traps have been installed or used they must charge up before they can be activated. The status of their "Charge Time" will be displayed on the "Item Charge Time Bar" in the lower right corner of the screen. When the charge level reaches the maximum capacity the traps are ready to be activated. Charge time differs depending on the traps.

D. Regaining Power

Your stamina is displayed on the "Hit Point Bar" in the lower left corner of the screen. During 3D Battle mode you fully regain strength by touching the loon in the castle. You can use the loon only once per each mission. You will also automatically regain full strength upon the conclusion of each mission.

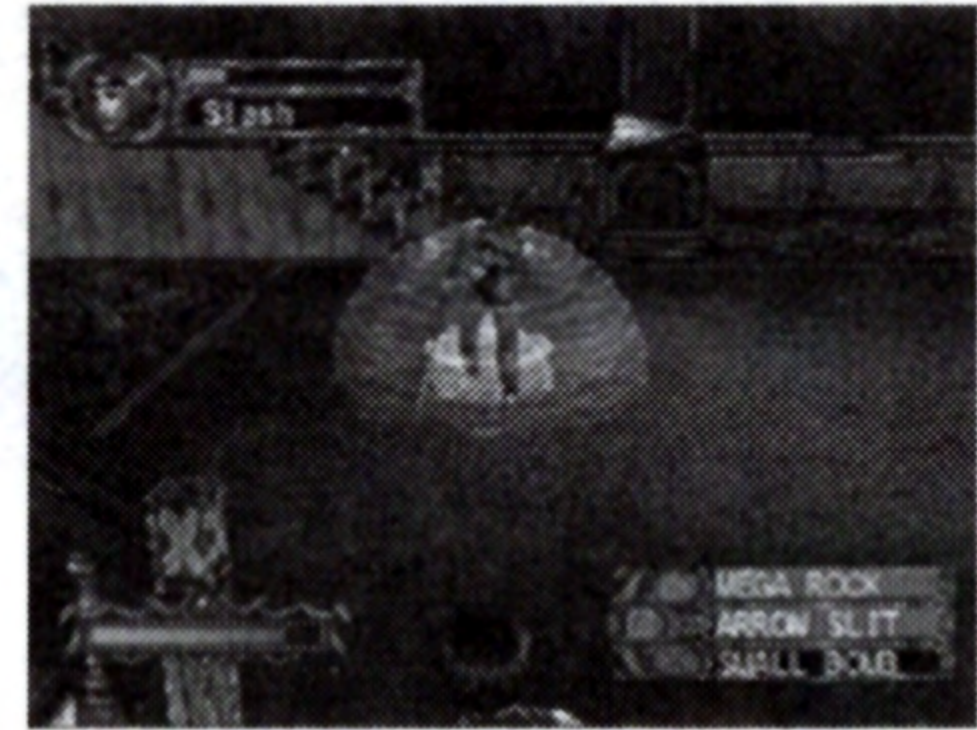
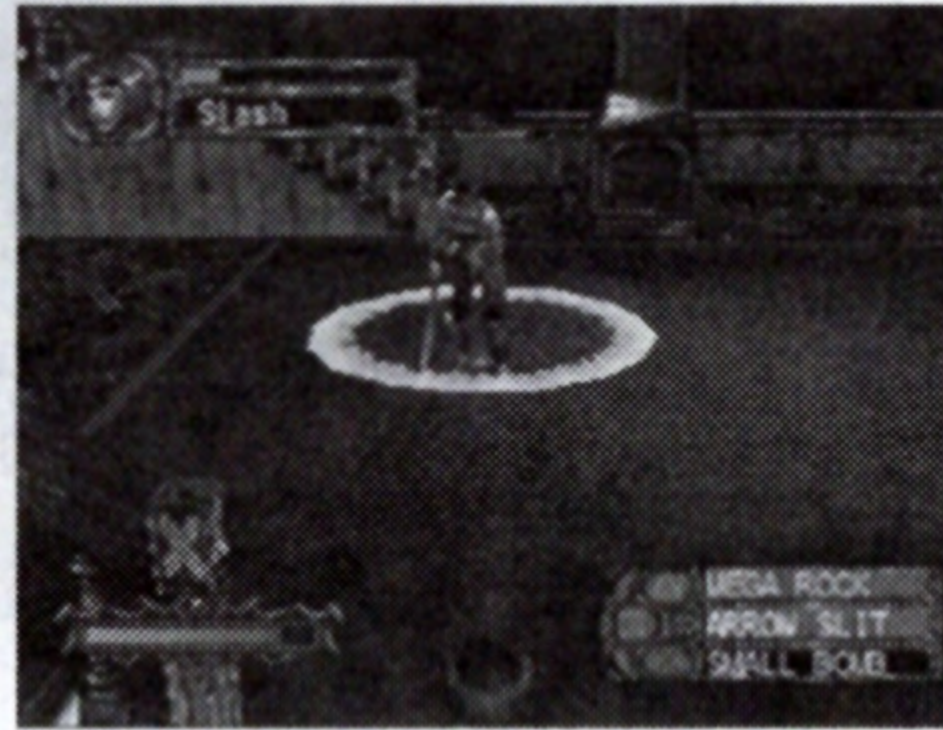

THE REFERENCE

A. The Floor Plan of the Timenoids' West Castle

This is the first castle you must conquer.

Entrance Room

Altar Room

Storage

Torture Room

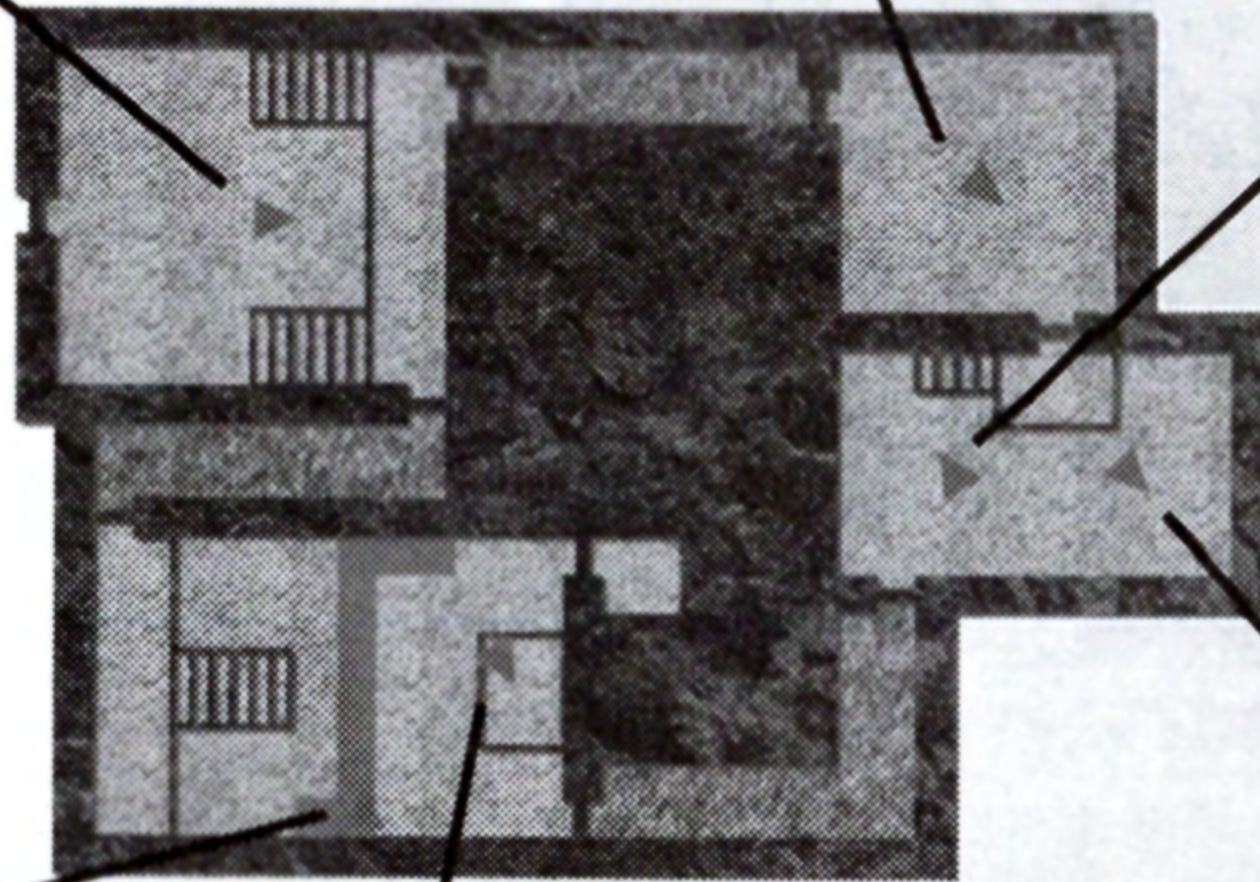

B. Traps

The following are a few of the traps that you can manipulate.

Ceiling Traps

MEGA ROCK: A rock drops from the ceiling and rolls across the floor and down stairs or inclines. This rock shatters upon impact with victim.

VASE: A vase drops from the ceiling. If you aim correctly the vase will hit your victim's head and temporarily blind him.

Wall Traps

PRESS WALL:

Wall advances 2 blocks at a time; forcibly pushes victims out of its path.

ARROW SLIT:

Razor-sharp arrows shoot from a mask on the wall.

Floor Traps

SMALL BOMB:

Small bomb explodes, blasting victim 2 blocks.

BEAR TRAP:

Iron blades emerge from floor and pin victim temporarily in place.



C. Devices

The devices below have already been set up in the castle. You can attack effectively if you utilize the devices in combination with the traps. (Careful: you're not safe from the effects of the devices either!)

Wall Spears: Razor-sharp spears shoot from the wall like clockwork, inflicting damage upon impact.

Volt Chair: Your typical, run-of-the-mill electric chair. This chair will shock upon contact, so watch out!

Oil Barrel: This is a barrel containing (what else?) oil! If the barrel is broken oil will ooze out, creating a slick. The slick causes victims to slip and impede their movement for a certain period of time.



D. Invaders

The following are a few of the invaders you may face during your mission. Each has his or her own reason for invading the castle.



Daar: A villager in the neighborhood. He is very weak and does not have any particularly lethal combat skills. He believes the rumor about how to become a Timenoid and therefore goes to the castle.



Lilia: The wife of Daar. She is worried about her husband, who has not yet returned from his quest to the castle.



Slash: A mercenary hired by Lilia, known as an able man among his fellow villagers.



Gastone: A friend of Slash. Speaks softly and carries a huge hammer.

CLUES TO CONQUER

A. Use A Combo Attack

It is difficult to correctly time ceiling traps. Since the target is also moving the trap might not hit the target by the time it reaches its impact point. Therefore it is sometimes better to hit the target with either a floor trap or a wall trap first. Then drop the ceiling trap while the target is immobilized. For example, you can push your target away with the Attack Wall, then drop the Mega Rock onto him. Activating traps continuously like this and hitting the target is called a "Combo." It is essential to knock out the target quickly and accurately. This technique will also affect the numbers of Ark you will receive at the end of a mission.

B. Read the Invader's Route

Since you cannot activate the traps immediately after setting them up, you must stay on the move until the traps are fully charged. Ideally you should try to have the traps charged before the invaders enter the room. This is when checking the map comes in handy. Strategies can be planned and the route that the invaders might take can be based on the map data. Check the whereabouts of the invaders, the floor plan, the devices in each room, and the geographic features. Then move to the room that you think the invader will enter next, and set the traps up.

CREDITS

Main Planner

Shibata Makoto

Scenario Writer

Suganuma Masao

Map Designer

M. Tsuboko

Cg Data Manager

M.J. Toyoda

Main Programmer

Kikuchi Keisuke

Battle System Programmer

Takasaki Toshiyuki

Event Programmer

Masataka

Sound Programmer

Nagaura Masaaki

Stage Programmer

Wariya Shiro

Trap Design Director

Shibata Makoto

Modeling

Nakamura Tamotsu

Uehara Yasushi

Horiuchi Kazuyoshi

Texture Designer

Omine Takeshi

Horiuchi Kazuyoshi

Shinzato Ryoto

Character Design Director

Shibata Makoto

Designer

Hirohisa Kaneko

Watanabe Hiroki

Modeling

M. Ikarashi

Hirohisa Kaneko

Watanabe Hiroki

Hayashi Hideki

Texture Designer

Hirohisa Kaneko

Watanabe Hiroki

Kanaoka Takenhiko

Hirose Yoichi

Komatsu Makoto

Matsumura Yasuhiko

Sasaya Naofumi

Ota Daisuke

Stage Design Director

Omori Takeshi

Modeling

Komatsu Atsushi

Rieijima

Texture Designer

Sakurada

Komatsu Atsushi

Rieijima

Hosoya Yukio

Hirohisa Kaneko

Watanabe Hiroki

Motion Design Director

M.Ikarashi

Designer

Osamu Honma

Katsuyuki Shimizu

Yoshizawa Yoshikatu

Special Thanks to Team Ninja:

Itagaki Tomonobu
Isomine Makoto
Matsui Hiroaki
Sasaki Chitose
Mishima Toru
Kondo Jitsu
Sato Masanori
Izumi Akira
Saitoh Hideki
Naruse Yuki
Morimoto Manabu
Ishizuka Shigefumi
Ikeda Ryuji
Koshikawa Masaki

Event Data Work
Takamiya Koji
Yamaguchi Hidehisa
Tange Toshiharu
Seino Kojiro

Sound Composer
Miyashiro Sugito
M. Udagawa
Toyoda Ayako

Art Work
Nishimura Junichi
Horiuchi Kazuyoshi

Marketing & Publicity

Linda Shannon
Michelle Nilsen

Package & Manual Design
MOORE & PRICE DESIGN GROUP

Internal Game Evaluation
Brian Hoisko

Manual Translation
Hiroko Stanhope
Setsuko Iwamoto

All-Around support
Norma Matautia

Director
Omori Takeshi

Producer
Hayakawa Takayoshi

Executive Producer
Max Naka

For game hints call our game counselor at 310-787-2900
between the hours of 8:30am~4:00 pm pacific time.

LIMITED WARRANTY

90-DAY LIMITED WARRANTY:

Tecmo, Inc. ("TECMO") warrants to the original consumer that this Tecmo Product ("TPR") shall be free from defects in material and workmanship for a period of 90 days from date of purchase. If a defect covered by this warranty occurs during the 90-day warranty period, Tecmo will repair or replace the TPR, at its option, free of charge.

To receive this warranty service:

1. DO NOT return your defective TPR to the retailer.
2. Notify the Tecmo Consumer Division of the problem requiring warranty service by calling: 1-310-787-2900. Our Consumer Service Department is in operation from 8:00 A.M. to 5:00 P.M. Pacific Time, Monday through Friday
3. If the Tecmo service technician is unable to solve the problem by phone, he will provide you with a Return Authorization number. Simply record this number on the outside packaging of your defective TPR, and return your TPR freight prepaid, at your risk of loss or damage, together with your sales slip or similar proof-of-purchase within the 90-day warranty period to:

Tecmo, Inc. Consumer/Service Department:
Sequoia Commerce Center
19260 S. Van Ness Avenue
Torrance, CA 90501

This warranty shall not apply if the TPR had been damaged by negligence, accident, unreasonable use, modification, tampering, or by other causes unrelated to defective materials or workmanship.

REPAIRS AFTER EXPIRATION OF WARRANTY:

If the TPR develops problems after the 90-day warranty period, you may contact the Tecmo Consumer Department at the phone number noted above. If the Tecmo service technician is unable to solve the problem by phone, he may provide you with a quote for the repair cost and a Return Authorization number. You may then record this number on the outside packaging of the defective TPR and return the defective TPR "freight prepaid" to Tecmo, enclosing a check or money order for the amount quoted payable to Tecmo, Inc. Tecmo will, at its option, subject to the conditions above repair the TPR or replace it with a new or repaired TPR. If replacement TPRs are not available, the defective TPR will be returned and your payment refunded.

WARRANTY LIMITATIONS

ANY APPLICABLE IMPLIED WARRANTIES, INCLUDING WARRANTIES OF MERCHANTABILITY AND FITNESS FOR A PARTICULAR PURPOSE, ARE HEREBY LIMITED TO NINETY DAYS FROM THE DATE OF PURCHASE AND ARE SUBJECT TO THE CONDITIONS SET FORTH HEREIN. IN NO EVENT SHALL TECMO BE LIABLE FOR CONSEQUENTIAL OR INCIDENTAL DAMAGES RESULTING FROM THE BREACH OF ANY EXPRESS OR IMPLIED WARRANTIES.

The provisions of this warranty are valid in the United States only. Some states do not allow limitations on how long an implied warranty lasts or exclusion of consequential or incidental damages, so the above limitations and exclusion may not apply to you. This warranty gives you specific legal rights, and you may also have other rights which vary from state to state.



The Purest Fighting Game for Purist Fighting Game Fans

**ON SALE NOW WHEREVER
PLAYSTATION® GAMES ARE SOLD!**

TECMO®

TECMO 19260 S. Van Ness Ave., Torrance, CA 90501
Phone (310) 787-2900 Fax (310) 787-3131 visit Tecmo at www.tecmo.com



Licensed by Sony Computer Entertainment America for use with the PlayStation game console. PlayStation and the PlayStation logos are registered trademarks of Sony Computer Entertainment Inc. Dual Shock is a trademark of Sony Computer Entertainment Inc. The ratings icon is a trademark of the Interactive Digital Software Association. Manufactured and printed in the U.S.A. THIS SOFTWARE IS COMPATIBLE WITH PLAYSTATION GAME CONSOLES WITH THE NTSC U/C DESIGNATION. U.S. AND FOREIGN PATENTS PENDING.